

A101
CONCEPTUAL SKETCH
TULE ELK

OUTKAST
DESIGNS, LLC

www.outkastdesigns.com



TULE ELK



MEMBER
A I B D
AMERICAN INSTITUTE OF
BUILDING DESIGN

No.	Description	Date

CONCEPTUAL SKETCH

Owner	Project Number	9310-18
	Date	8-1-18
	Drawn By	SL
	OutKast Designs Po Box 30 Colusa, CA 95932 scott@outkastdesigns.com	

A101

Scale 1" = 1'-0"

8/25/2018 8:04:07 AM

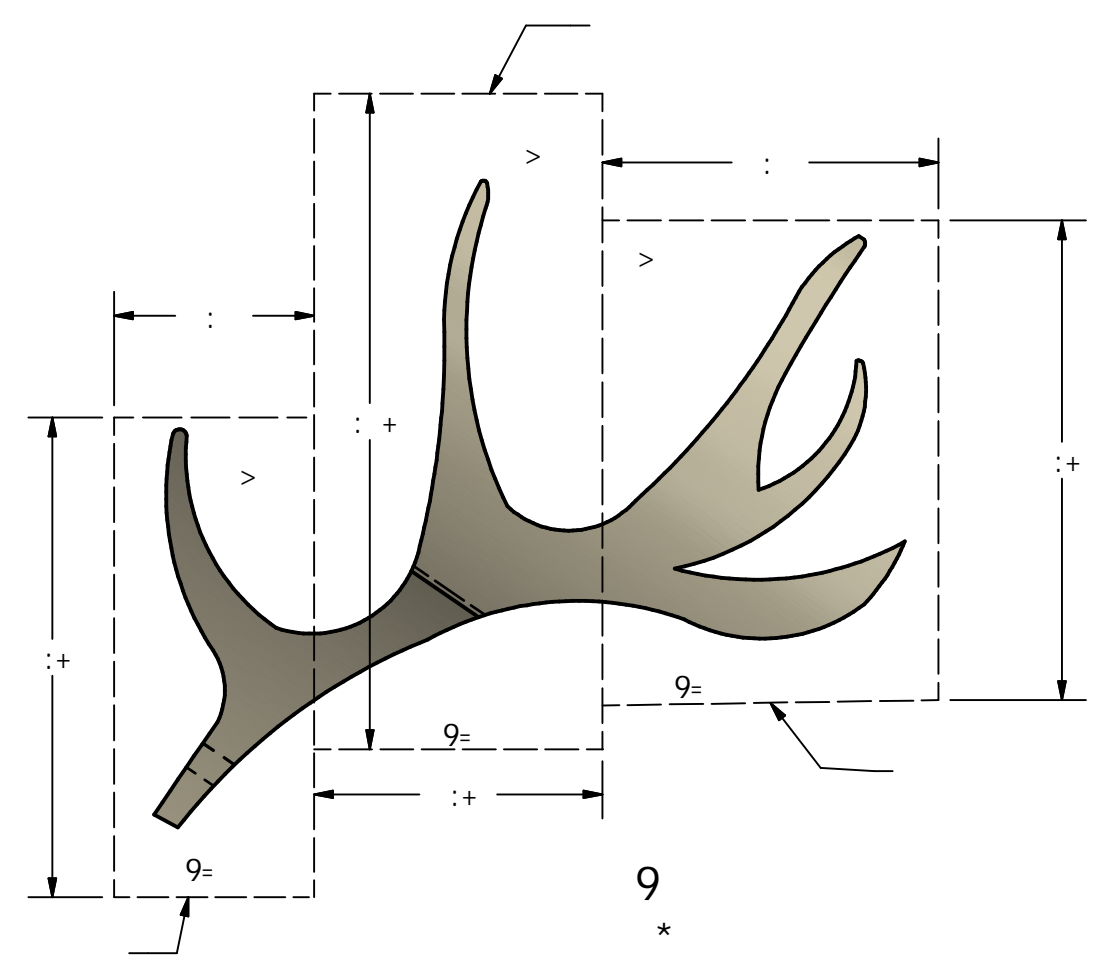
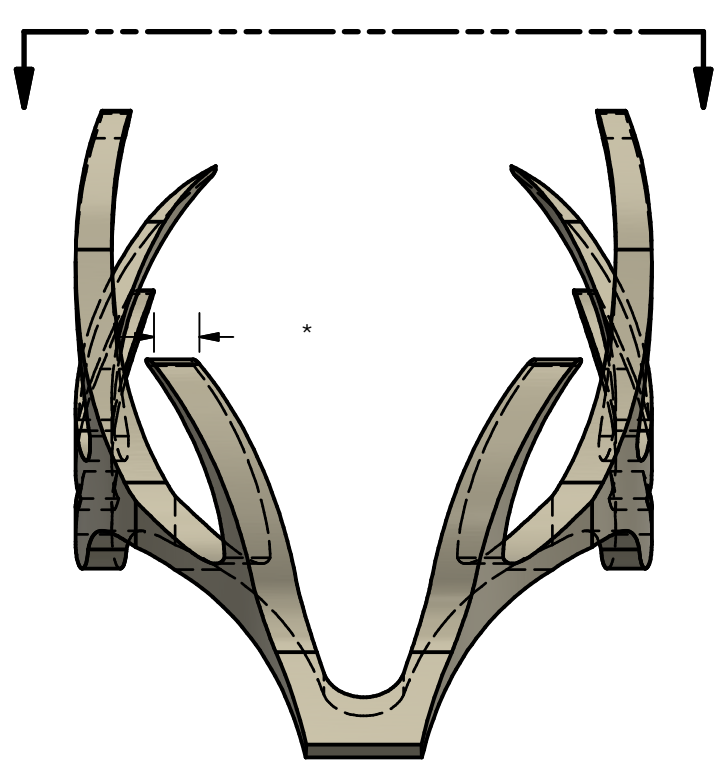
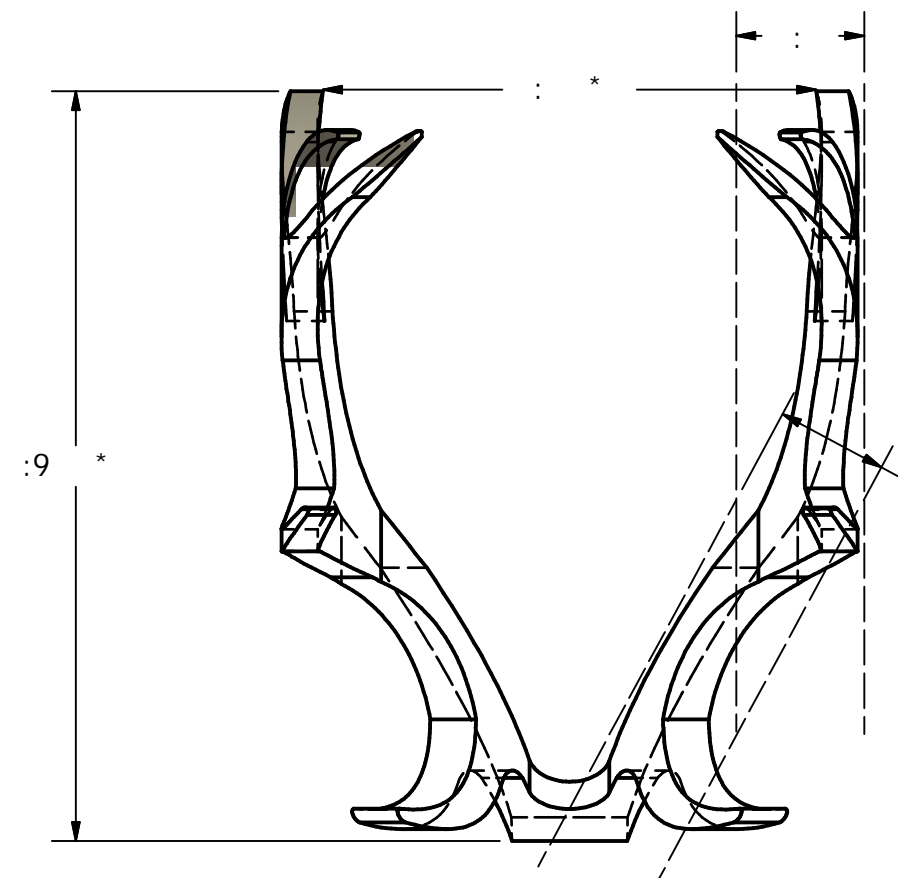
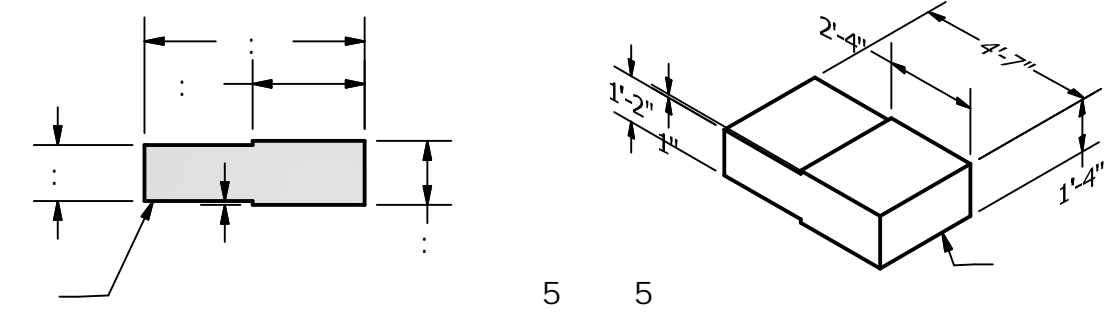
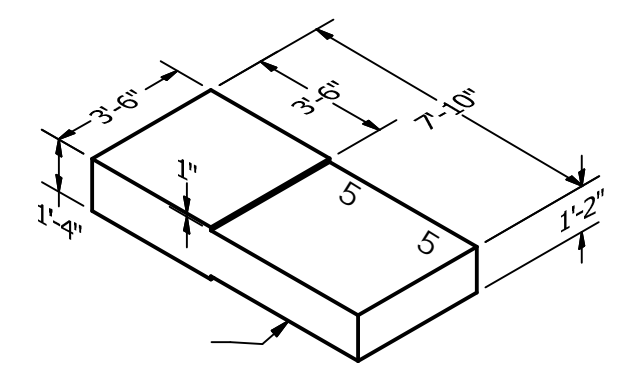
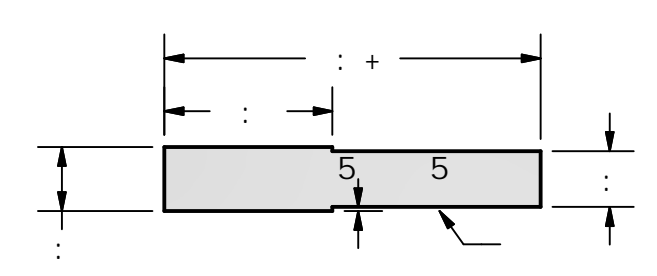
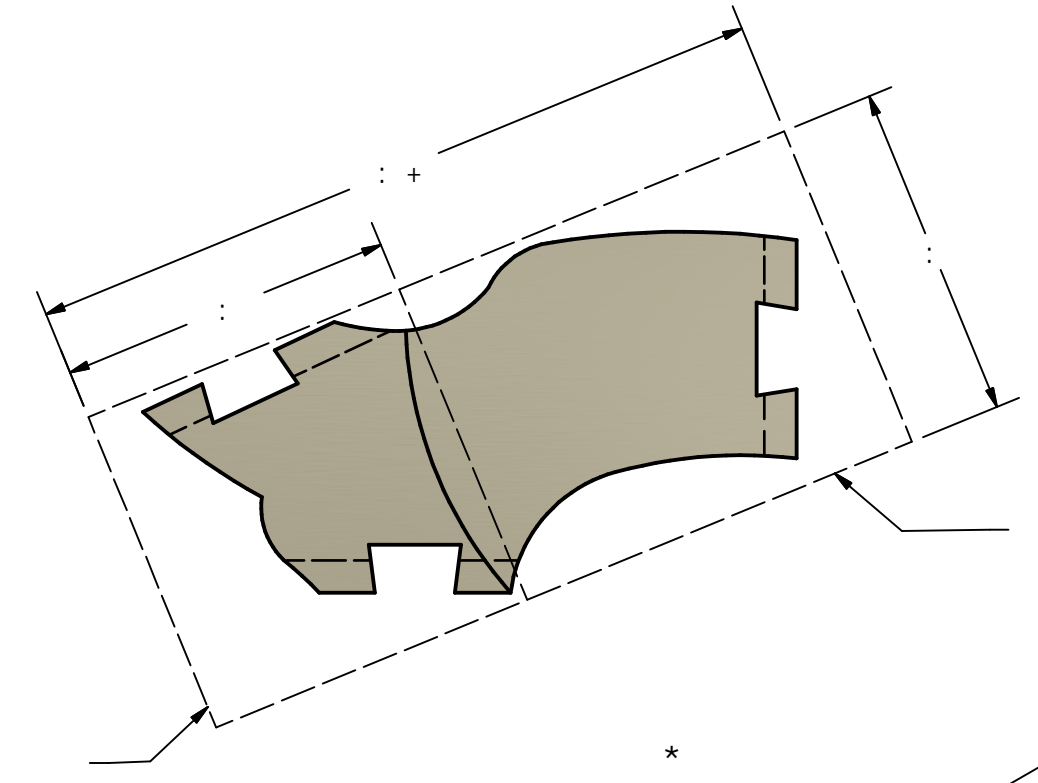
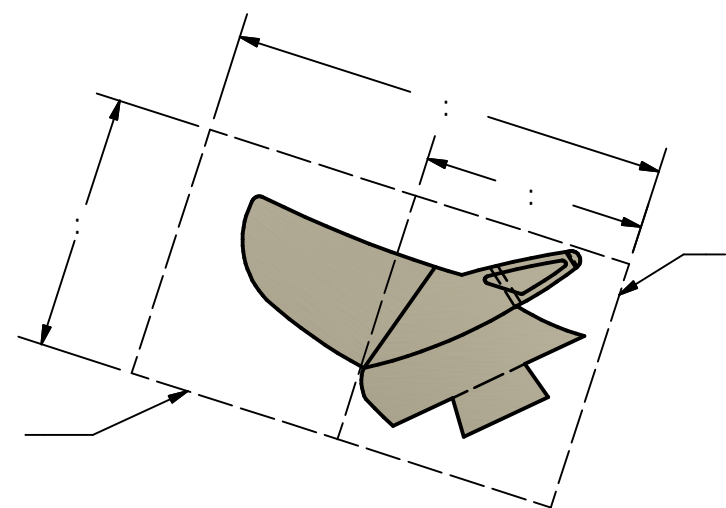
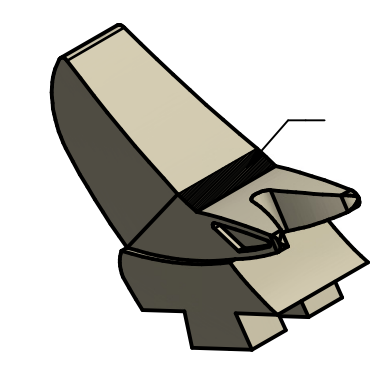
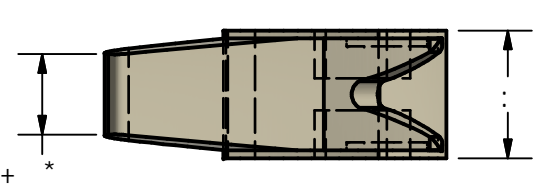
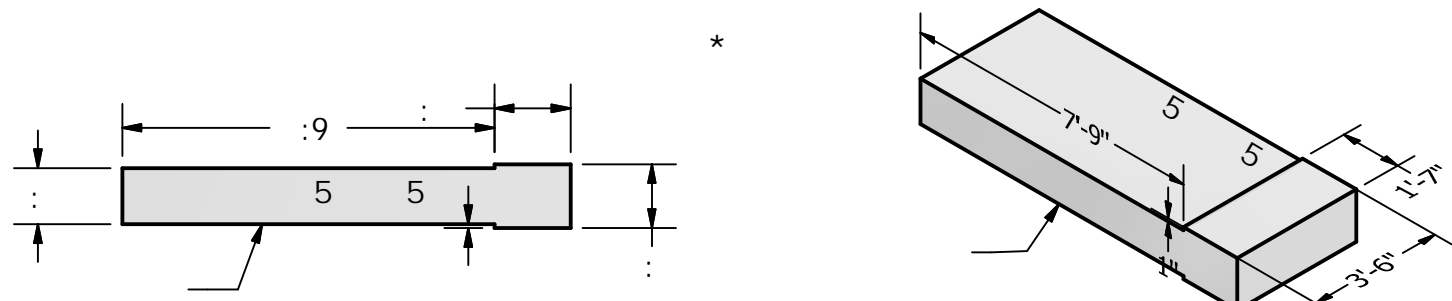
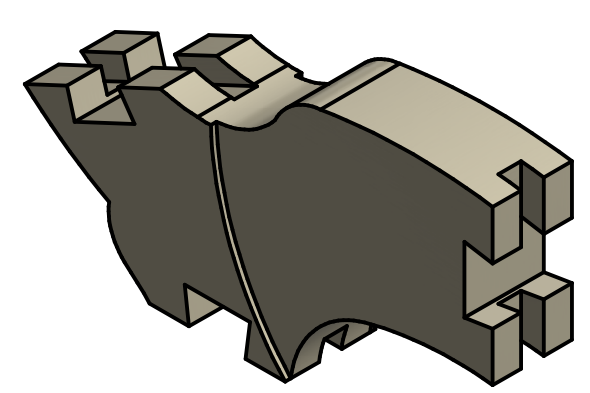
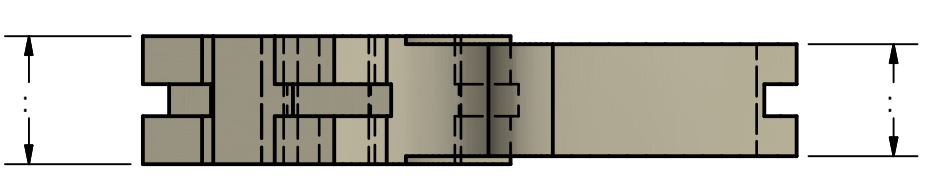
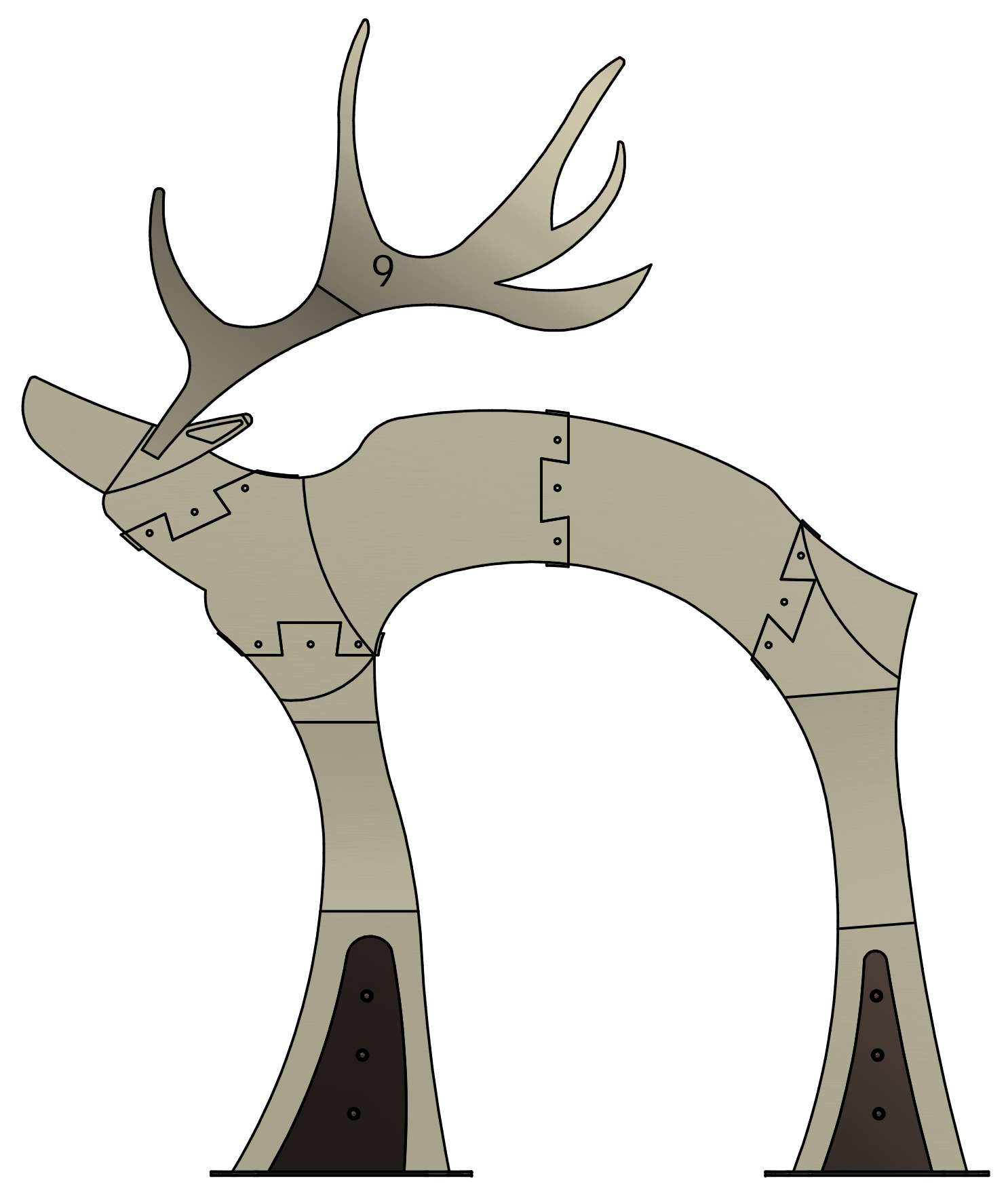
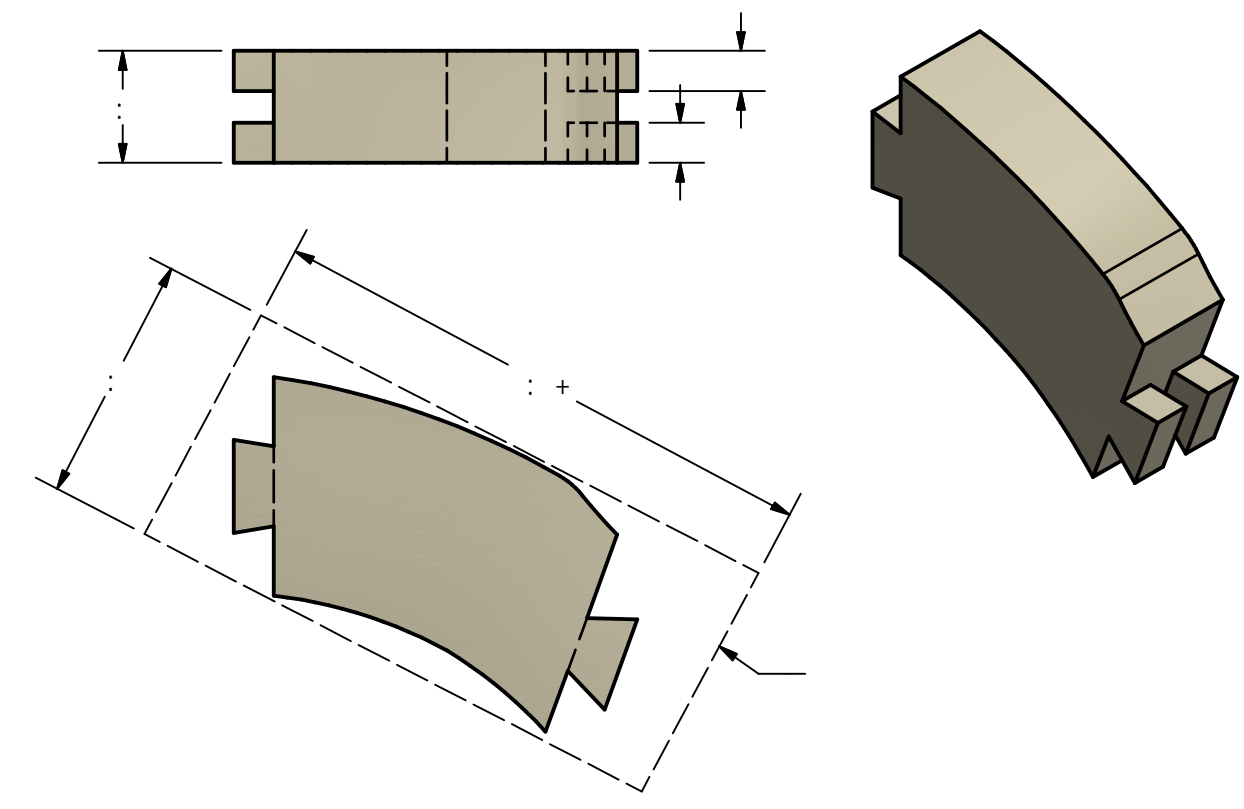
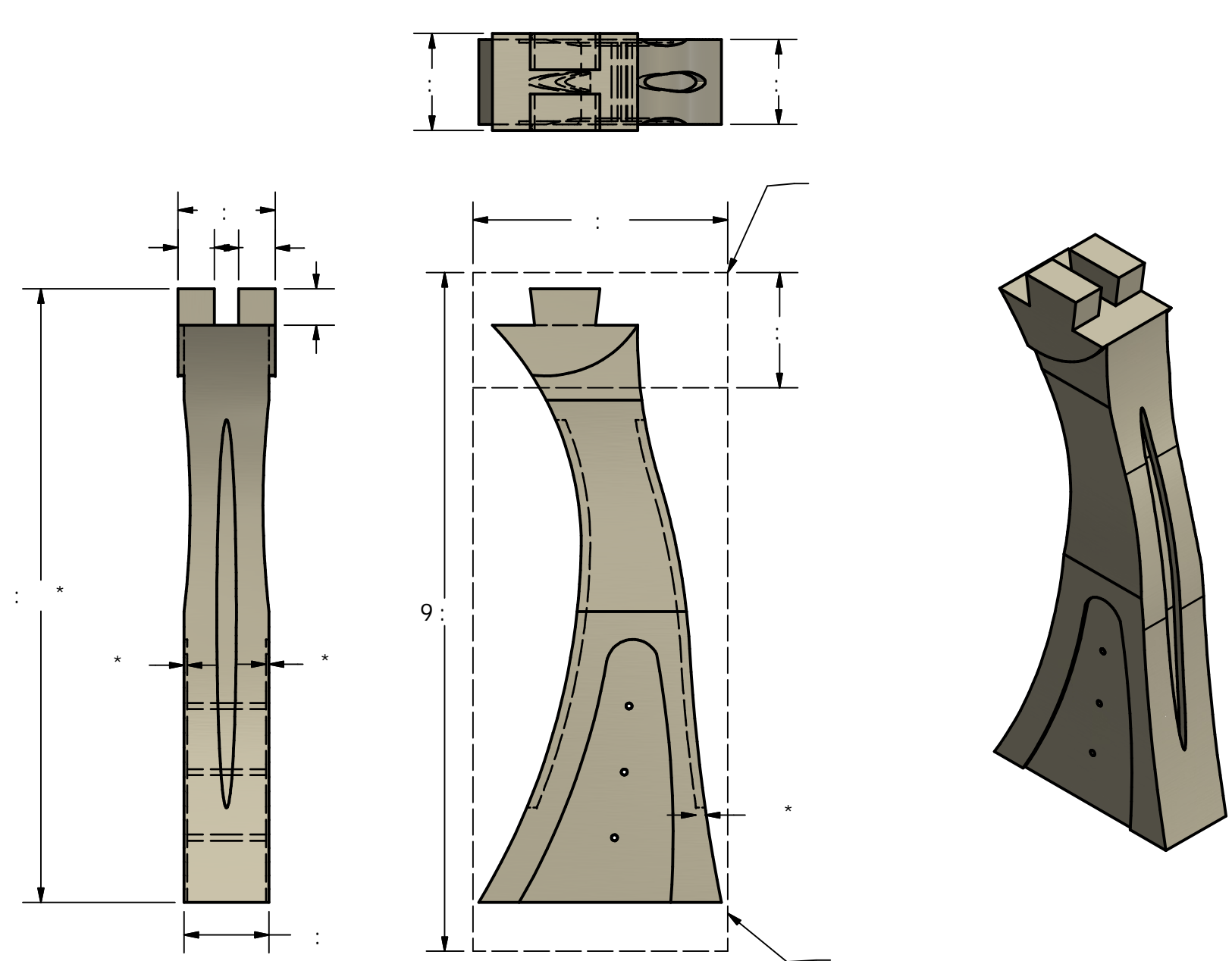
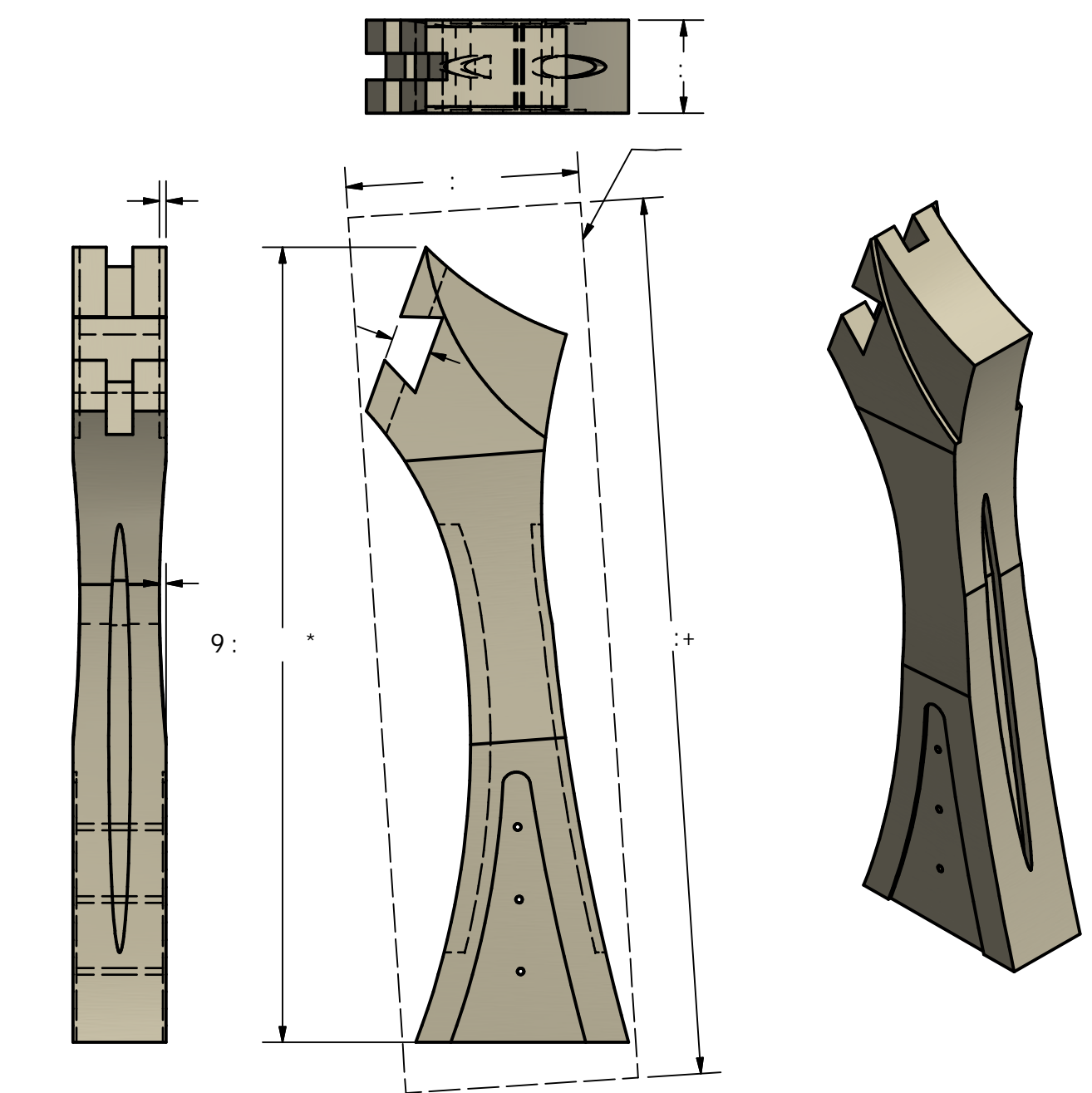

MATERIAL LIST											
Project Name:		TULE ELK		Species							
Contact:		Scott Lunsford		D E H S C							
Tele:		530-216-5050		F U C M P U R							
				# 1 2							
Item	Description	Quantity									
TIMBER CUTS											
P1	2'-11" X 11" X 14"	1									
P3	3'-6" X 9'-4" X 14"	1									
	(FROM ONE END 1'-7" THICKEN TO 16")										
P4	2'-7" X 5'-10" X 14"	1									
P5	3'-6" X 7'-10" X 14"	1									
	(FROM ONE END 3'-6" THICKEN TO 16")										
P6	2'-8" X 4'-7" X 14"	1									
	(FROM ONE END 2'-4" THICKEN TO 16")										
P8.1	3'-6" X 5" X 13"	2									
P8.2	3" X 6'-0" X 14"	2									
P8.3	2'-1" X 5" X 12"	2									
P10, P21, P22, P24	4" X 4" X 3"	4									

MADE IN USA	5
OUTCAST DESIGNS	
01%23, "4	\$#, #-